



# IP65 LED Panel Light PL63MD



 [www.ofled-lighting.en.alibaba.com](http://www.ofled-lighting.en.alibaba.com)

100  
lm/W

- Light Efficacy up to 100lm/W.
- Approved from CE/RoHS.
- Protection Grade: IP65.
- 3 years warranty.



## Jiangsu Ofled Optoelectronics Technology Co.,Ltd

Factory address: No.9 Zhengfu Road Liangduo Town,Dongtai CityJiangsu Province,P.R. China.  
Tel: +86 515 85555809

Shenzhen Office: 446, Huafeng Internet+Creative Garden, No.107 of Gonghe Industrial Road, Xixiang Street, Bao'an District, Shenzhen, China.  
Tel: +86 755 23777180  
Email: [sales@ofled-lighting.com](mailto:sales@ofled-lighting.com) Web: [www.ofled-lighting.com](http://www.ofled-lighting.com)



[www.ofled-lighting.com](http://www.ofled-lighting.com)

## Specifications

Item No.	Watt(W)	Product Size(mm)	Light Efficiency (lm/W)	Input	Intelligent Control	CCT (K)
OHD-PL63MD-258XX	20-25	295*595*10mm	100	AC200-240V 50/60Hz	DALI 0/1-10V RX PWM	3000- 6500
OHD-PL66MD-368XX	36-40	595*595*10mm				
OHD-PL66MD-488XX	48	595*595*10mm				
OHD-PL123MD-368XX	36-40	1195*295*10mm				
OHD-PL123MD-488XX	48	1195*295*10mm				
OHD-PL126MD-558XX	55-60	1195*595*10mm				

PF	CRI(Ra)	Beam Angle	Working Temperature	Storing Temperature	Protection Grade	Warranty
0.95	80	110°	-20 °C ~ +50 °C	-30 °C ~ +80 °C	IP65	3 years

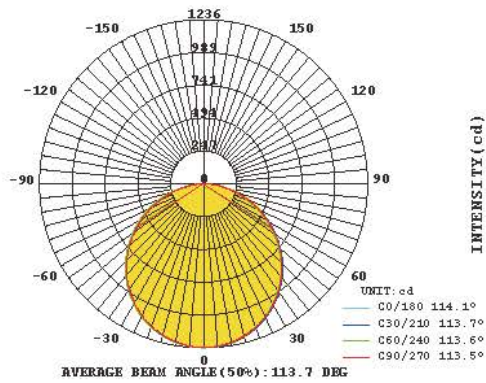

## Dimension

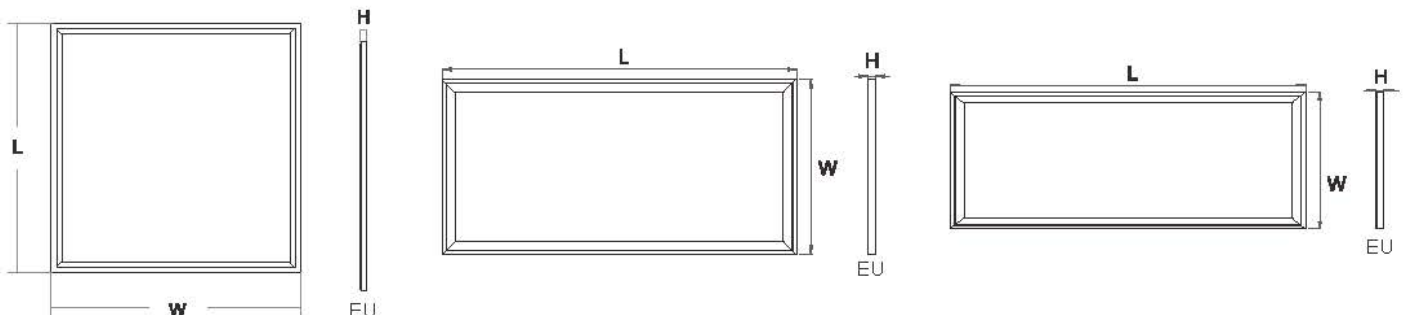

Watt(W)	20W-25W	36W-40W 48W	36W-40W 48W	55W-60W
Size	1x2	2x2	1x4	2x4
LxWxH (mm)	295x595x10	595x595x10	295x1195x10	595x1195x10

- There will be slight deviation in the actual situation, which is subject to the actual situation.

## Method 1 Insert Installation

- First please confirm the same size of panels and ceiling and remove the plate of the ceiling.
- Make the panels input wire connected with driver's output wire.
- Tilt the panels to the ceiling diagonally into the ceiling frame.

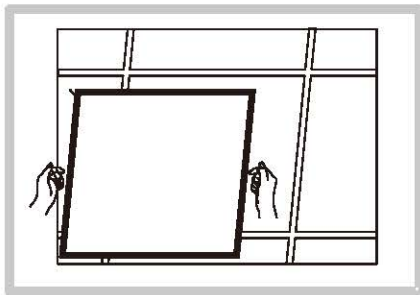

Step1

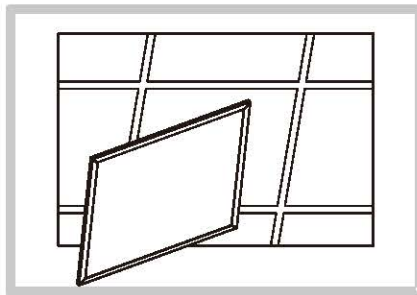

Step2

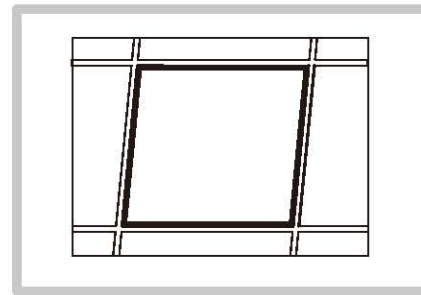

Step3

## Method 2 Suspended Installation

- Use electric drill to make a hole in the plaster ceiling, and fix the expansion screw on it.
- Make the rope go through the hole of the holder on panel light.
- Make the rope go through the ring, and adjust to suitable length.
- Make the four rings hand on the expansion screw.

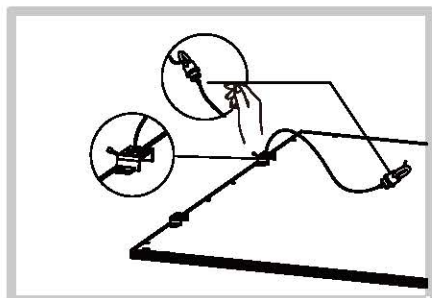

Step1

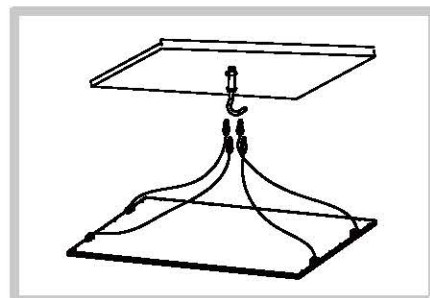

Step2

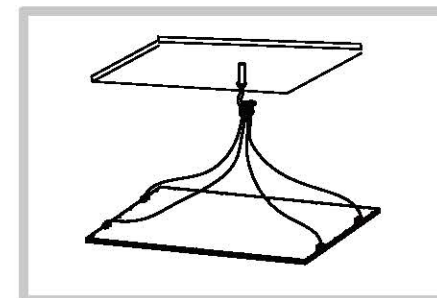

Step3

## Method 3 Surface Mounting Installation

- The scattered aluminium frame installation 3pcs frame and fix it to ceiling.
- Insert the panels into the frame in ceiling.
- Assembling the final frame boarder.

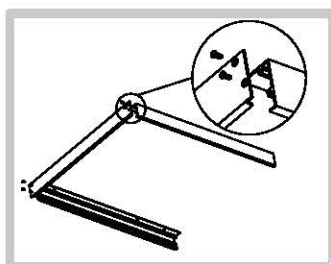

Step1

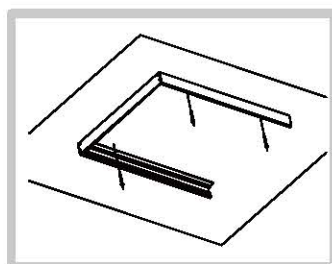

Step2

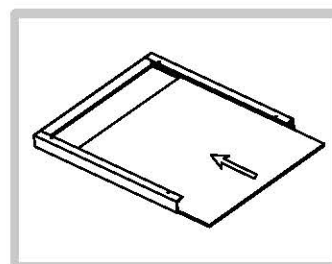

Step3

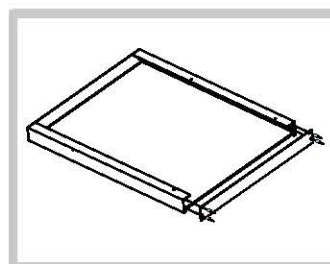

Step4



## Application



Car wash Room

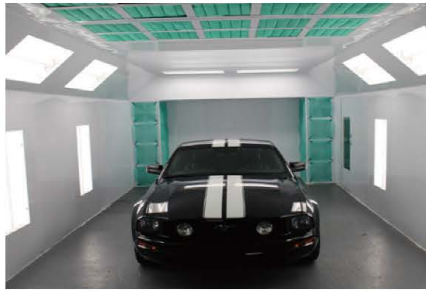

Car wash Room



Painting workshop



Hospital

- Hospital
- Petrol station
- Shower room
- SPA room
- Station platform
- Food workshop
- Painting workshop
- Indoor swimming pool
- Subway station
- All humid environments